

Block Diagram

REVISIONS			
REV	DATE	DESCRIPTION	APPROVED

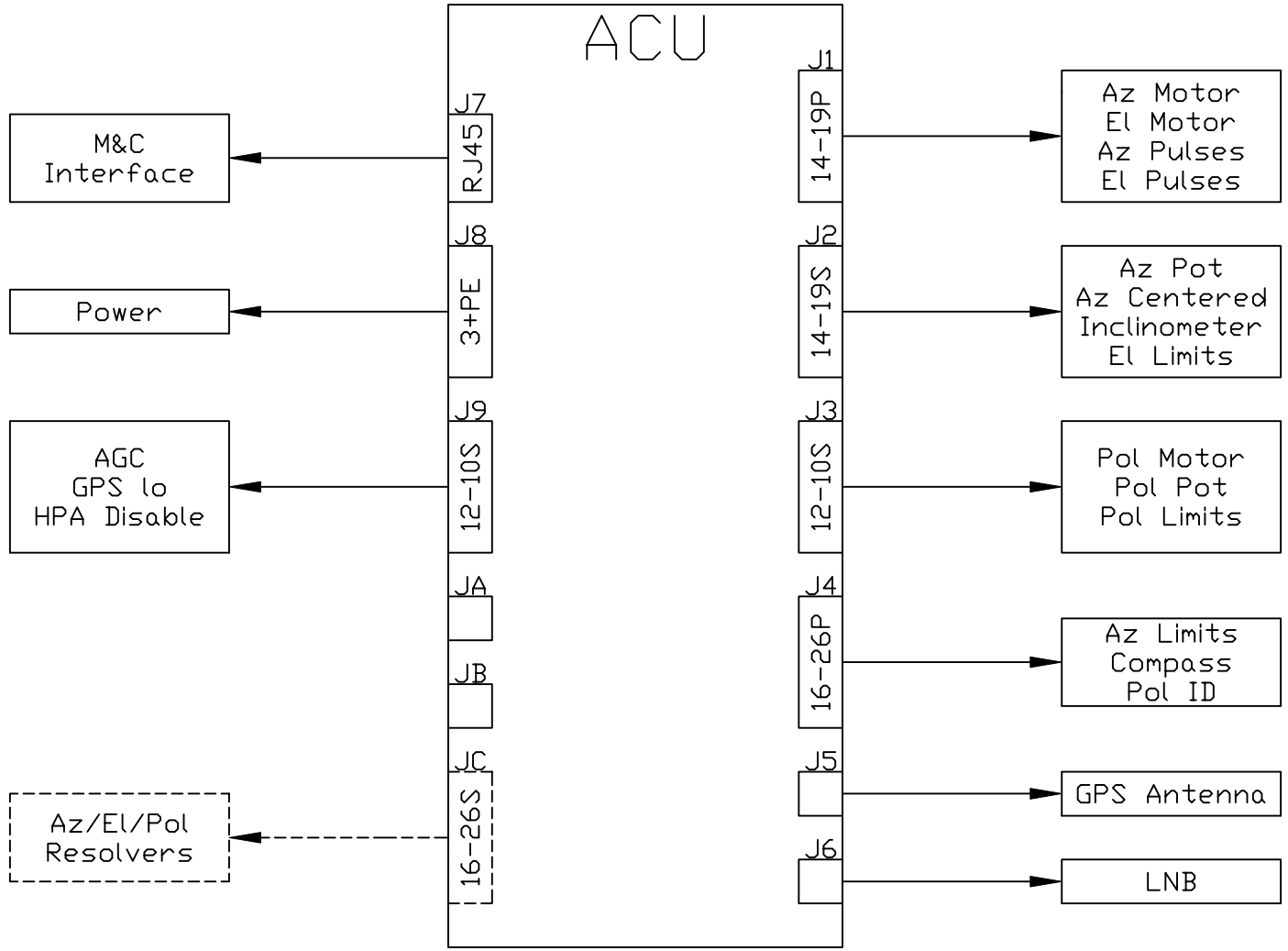

MATERIAL	Research Concepts, Inc.		
FINISH			
TOLERANCE			
FILENAME			
SHEET 1 OF 13	TITLE	3KAVR Emb Sys Connects	
SIZE A	DRAWN BY	DWG NO.	REV A
	ECG		

Power Distribution

REVISIONS		
REV	DATE	DESCRIPTION

PS#VPHUB820S

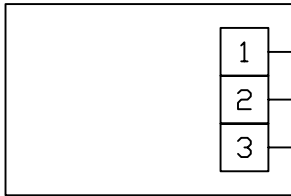

W-16G-RED-WHT

W-16G-BLUE

W-16G-WHT-BLK

PS#VP1646182E

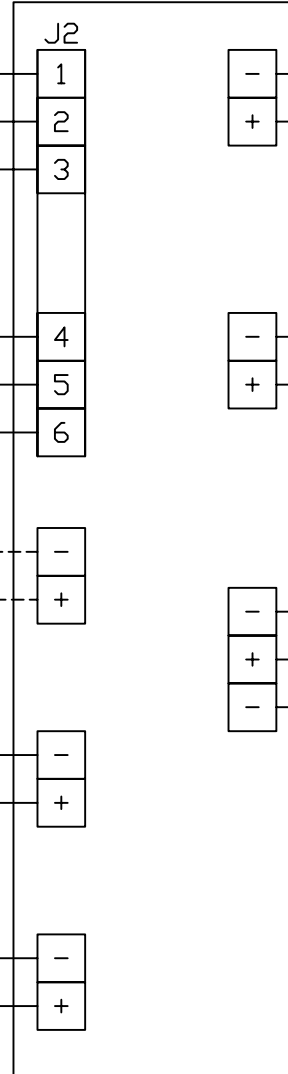

FC#3KAN5-B

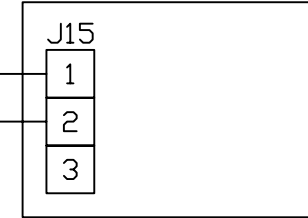

W-16G-BLACK

W-16G-RED

FC#3KDIG-1

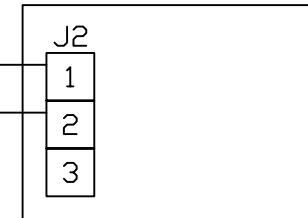

W-16G-BLACK

W-16G-RED

FB#3KMDC-A

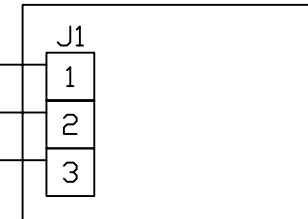

W-16G-BLACK

W-16G-RED

W-16G-BLACK

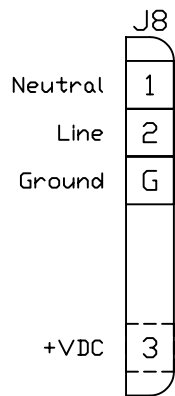

W-16G-WHITE

W-16G-BLACK

W-16G-GREEN

W-16G-GREEN

W-16G-RED

Z-FAN 24VDC



Z-FAN 24VDC



MATERIAL	
FINISH	
TOLERANCE	
FILENAME	
SHEET 2 OF 13	



Research Concepts, Inc.

TITLE	3KAVR Emb Sys Connects		
SIZE	DRAWN BY	DWG NO.	REV
A	ECG		A

Motor Connections

REVISIONS			
REV	DATE	DESCRIPTION	APPROVED

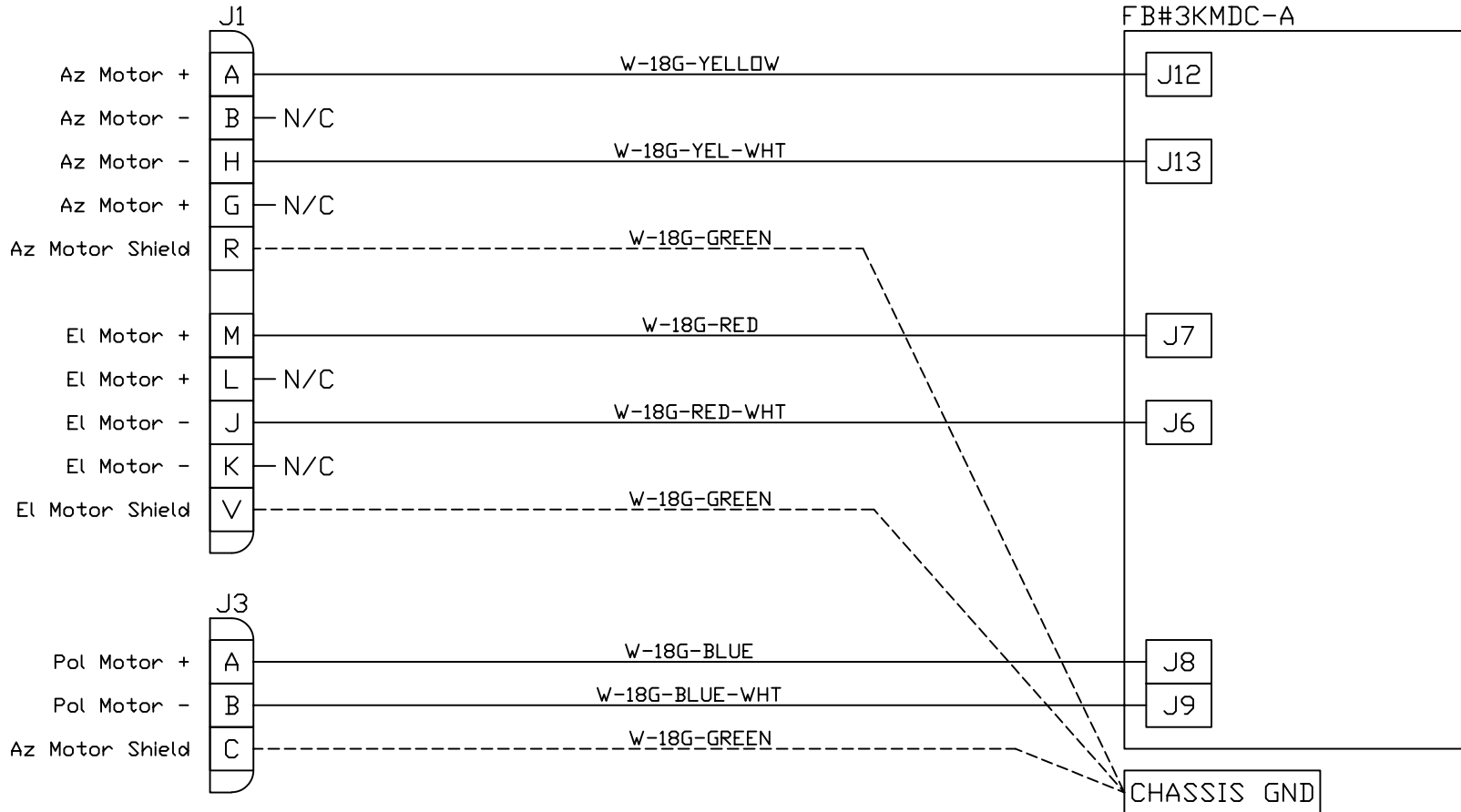

MATERIAL	 Research Concepts, Inc.		
FINISH	TITLE		
TOLERANCE	3KAVR Emb Sys Connects		
FILENAME	SIZE	DRAWN BY	DWG NO.
SHEET 3 OF 13	A	ECG	
			REV A

Antenna Inputs

Az/El Motor & Pol Position Feedback

REVISIONS			APPROVED
REV	DATE	DESCRIPTION	

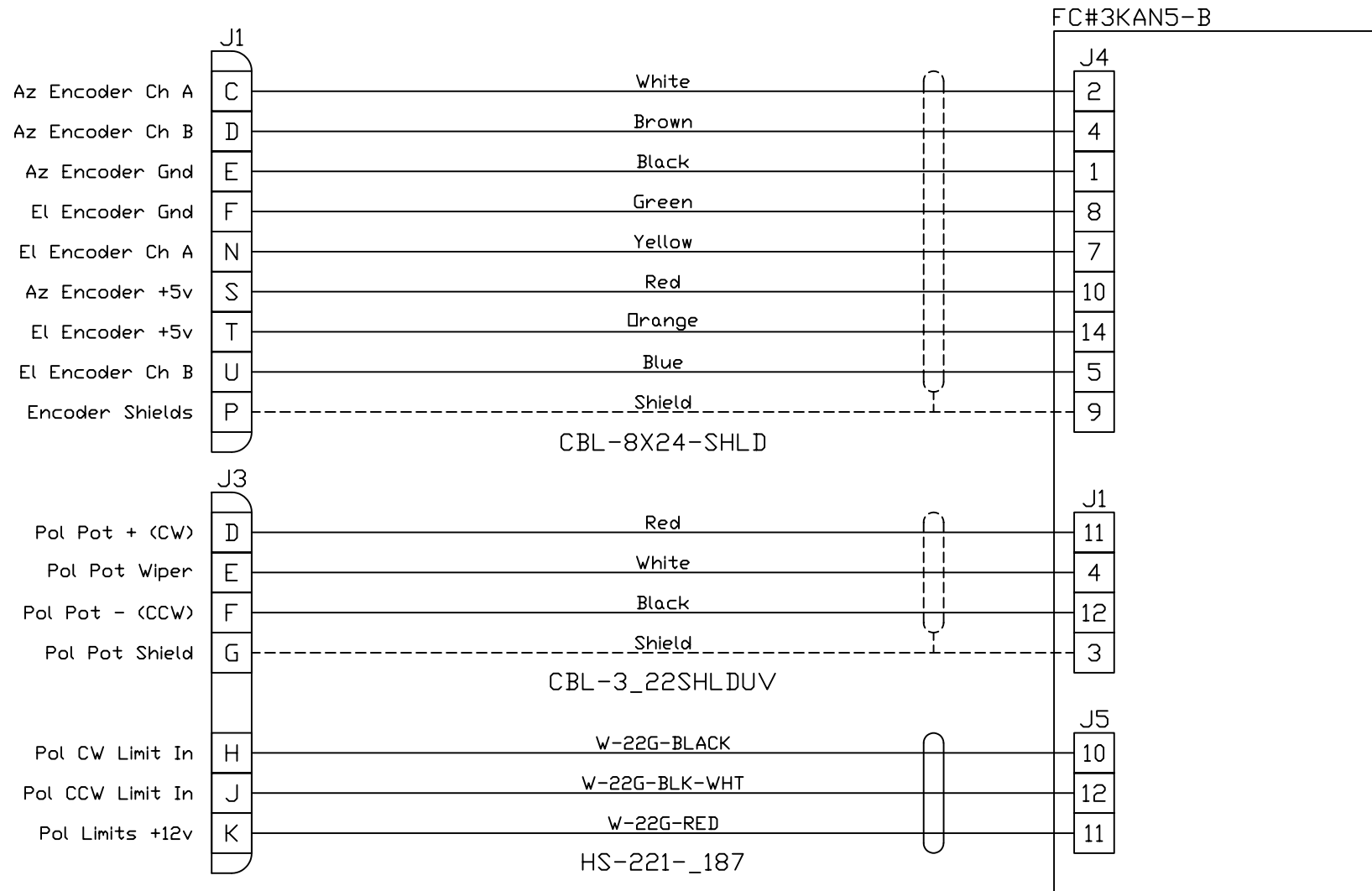

MATERIAL			
FINISH			
TOLERANCE			
FILENAME			
SHEET 4 OF 13	TITLE	3KAVR Emb Sys Connects	
SIZE A	DRAWN BY	DWG NO.	REV A
	ECG		

Antenna Inputs

Az/El Position Feedback

REVISIONS			APPROVED
REV	DATE	DESCRIPTION	

FC#3KAN5-B

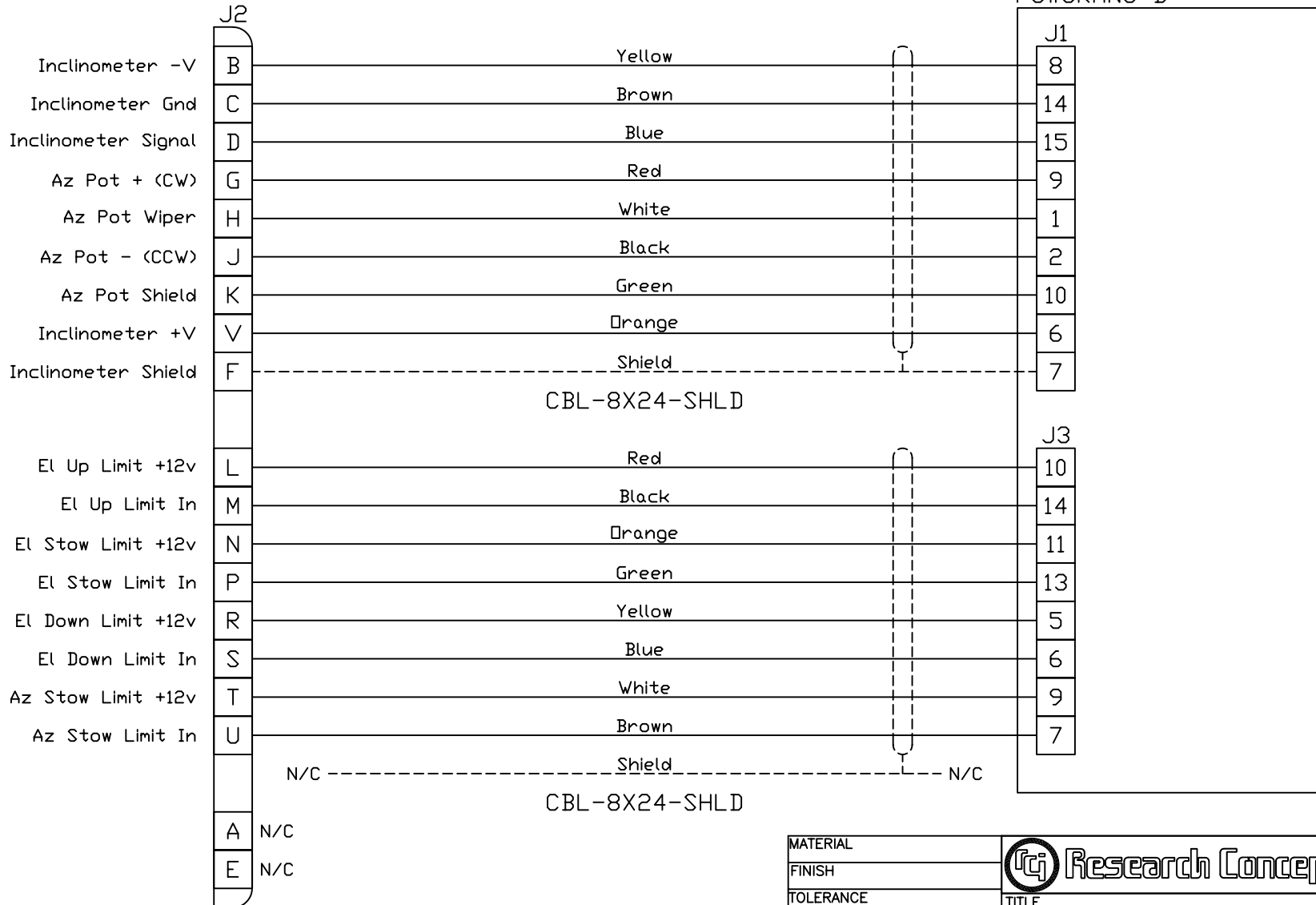



MATERIAL				REV
FINISH				A
TOLERANCE				
FILENAME				
TITLE		3KAVR Emb Sys Connects		
SHEET	5	OF	13	DWG NO.
SIZE	A	DRAWN BY	ECG	REV
				A

Antenna Inputs

Az Resolver Feedback

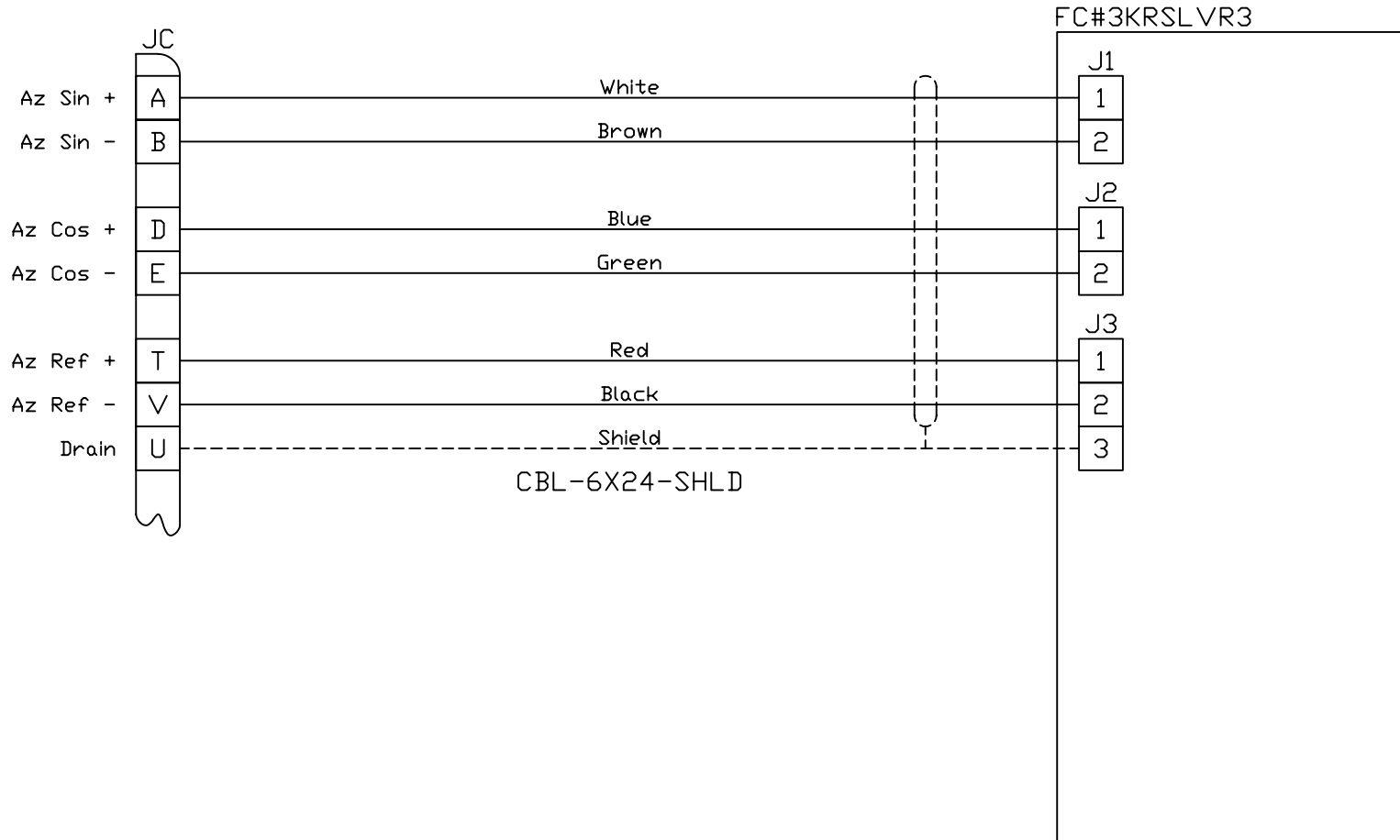
REVISIONS			
REV	DATE	DESCRIPTION	APPROVED



MATERIAL	 Research Concepts, Inc.		
FINISH			
TOLERANCE			
FILENAME			
SHEET 6 OF 13	TITLE	3KAVR Emb Sys Connects	
SIZE A	DRAWN BY ECG	DWG NO.	REV A

Antenna Inputs

El Resolver Feedback

REVISIONS			APPROVED
REV	DATE	DESCRIPTION	

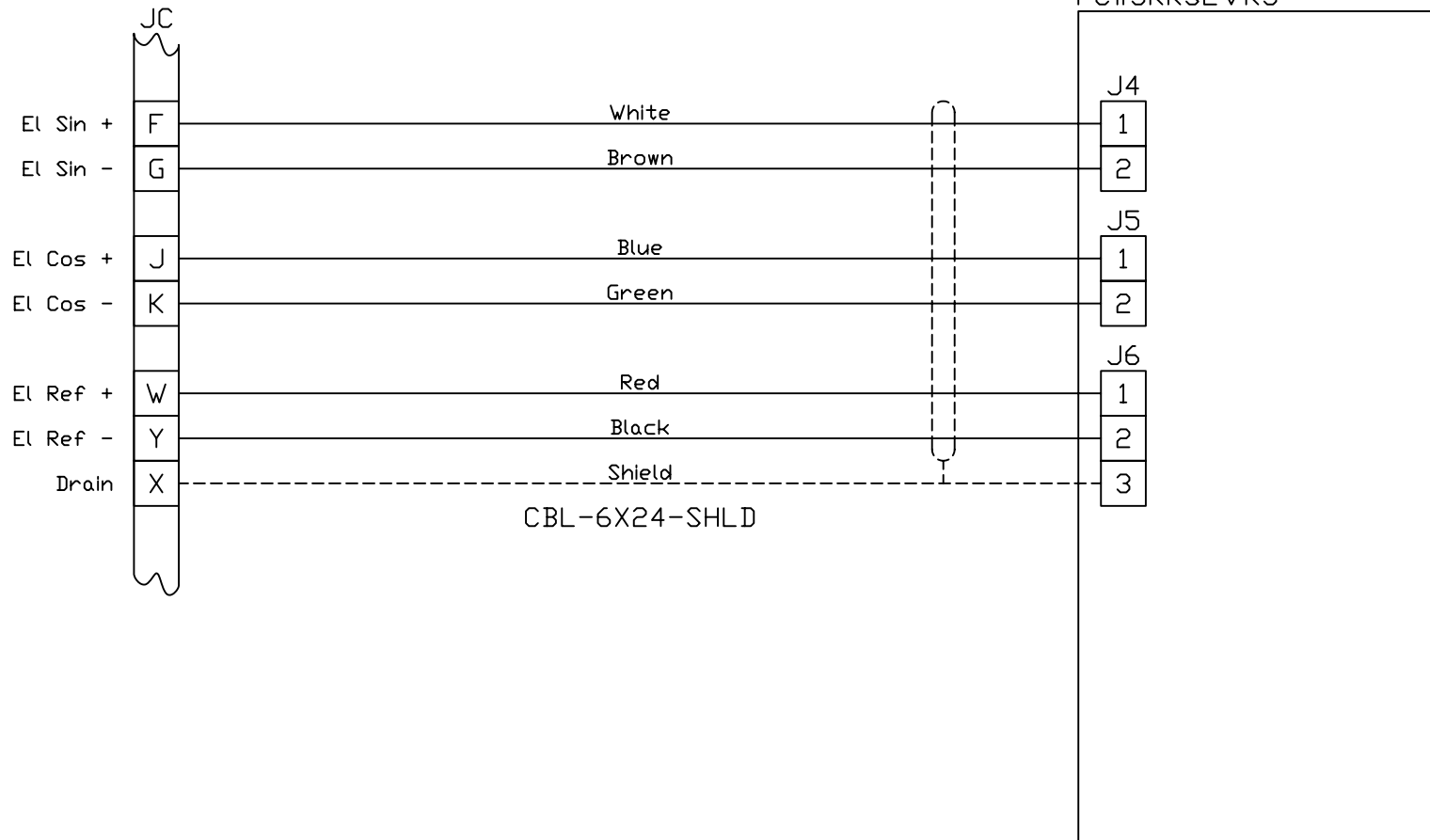



MATERIAL	 Research Concepts, Inc.		
FINISH	TITLE		
TOLERANCE	3KAVR Emb Sys Connects		
FILENAME	SIZE	DRAWN BY	DWG NO.
SHEET 7 OF 13	A	ECG	
			REV A

Antenna Inputs

Pol Resolver Feedback

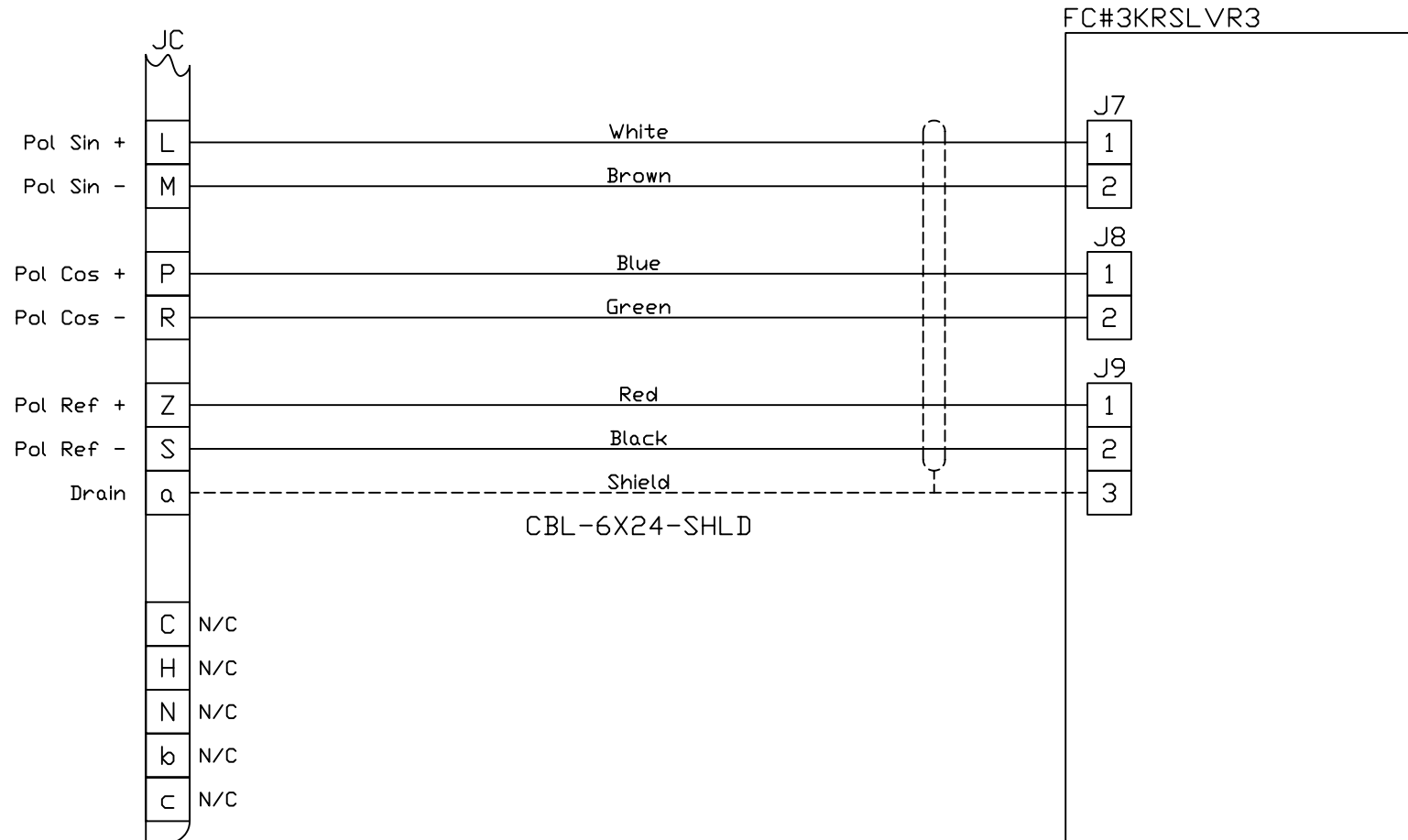
REVISIONS			
REV	DATE	DESCRIPTION	APPROVED





MATERIAL	 Research Concepts, Inc.		
FINISH	TITLE		
TOLERANCE	3KAVR Emb Sys Connects		
FILENAME	SIZE	DRAWN BY	DWG NO.
SHEET 8 OF 13	A	ECG	
			REV A

Accessories (1 of 2)

Antenna Interface Accessories

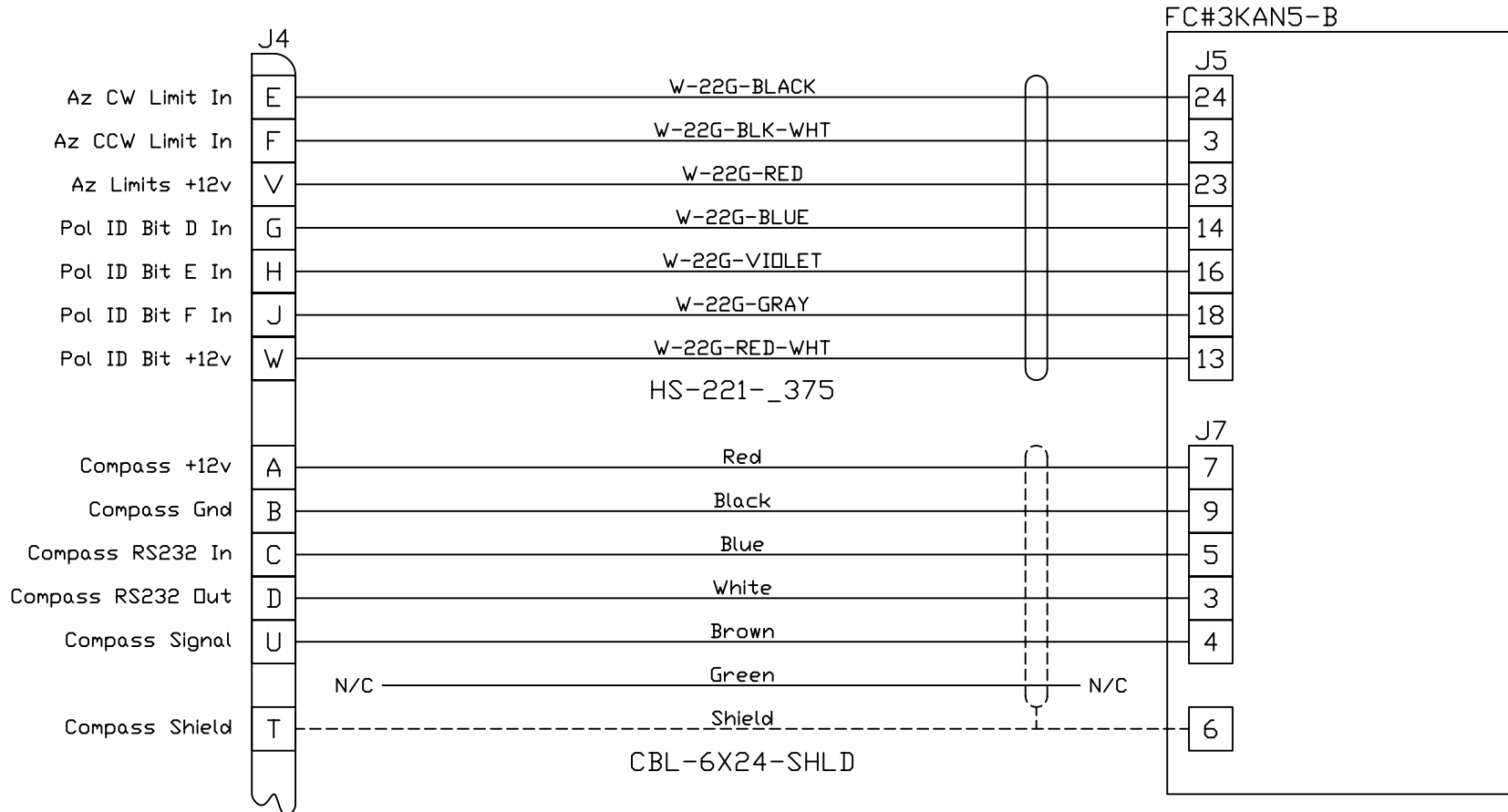
REVISIONS			APPROVED
REV	DATE	DESCRIPTION	





MATERIAL	 Research Concepts, Inc.		
FINISH	TITLE		
TOLERANCE	3KAVR Emb Sys Connects		
FILENAME	SIZE	DRAWN BY	DWG NO.
SHEET 9 OF 13	A	ECG	
			REV A

Accessories (2 of 2)

Antenna Interface Accessories

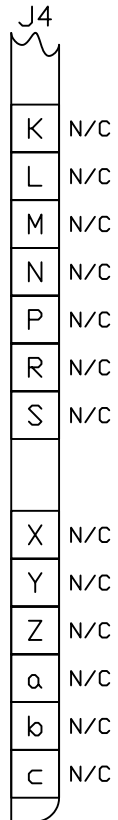
REVISIONS			
REV	DATE	DESCRIPTION	APPROVED





MATERIAL	 Research Concepts, Inc.		
FINISH	TITLE		
TOLERANCE	3KAVR Emb Sys Connects		
FILENAME	SIZE	DRAWN BY	DWG NO.
SHEET 10 OF 13	A	ECG	
			REV A

Accessories

User Interface Accessories

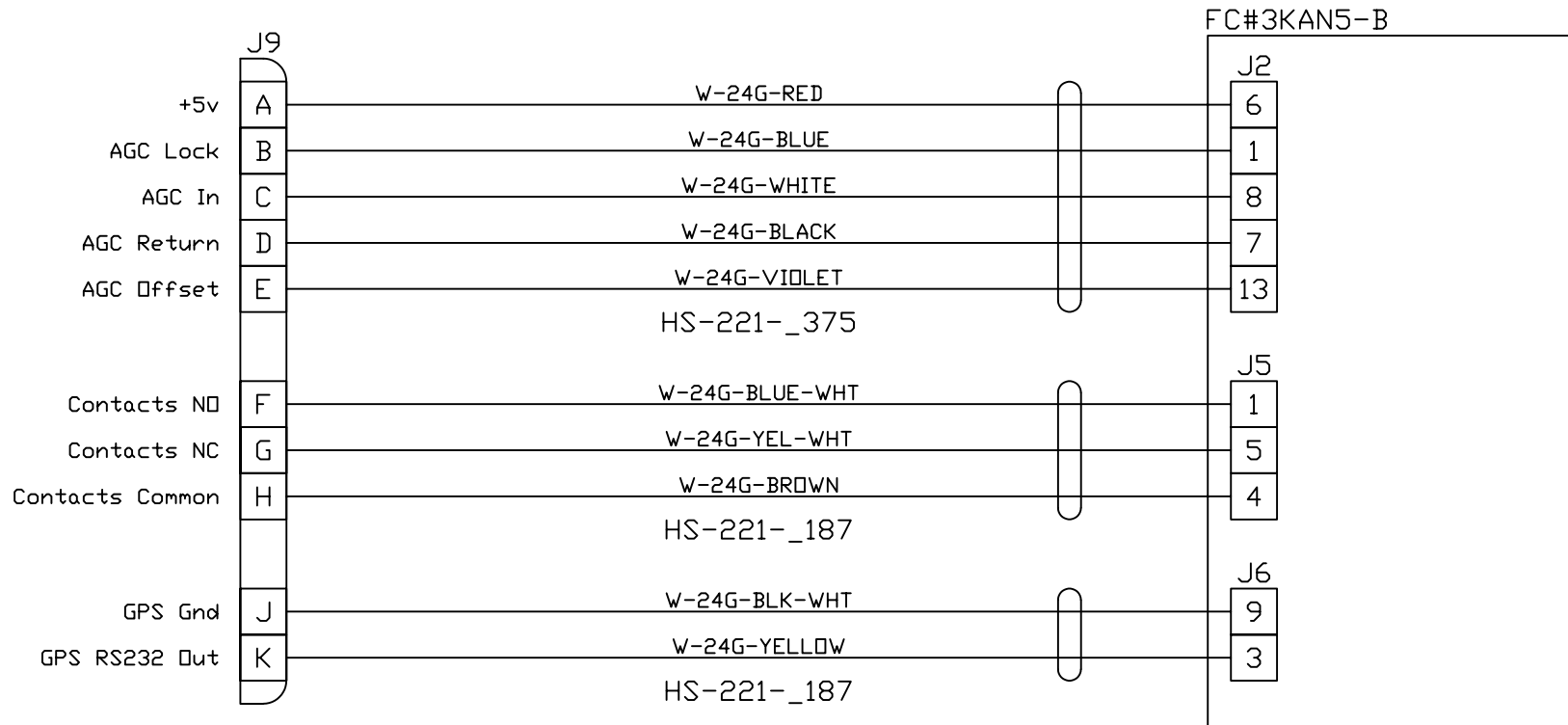
REVISIONS			
REV	DATE	DESCRIPTION	APPROVED



MATERIAL	 Research Concepts, Inc.			
FINISH	TITLE			
TOLERANCE	3KAVR Emb Sys Connects			
FILENAME	SIZE	DRAWN BY	DWG NO.	REV
SHEET 11 OF 13	A	ECG		A

RF Connections

REVISIONS			
REV	DATE	DESCRIPTION	APPROVED

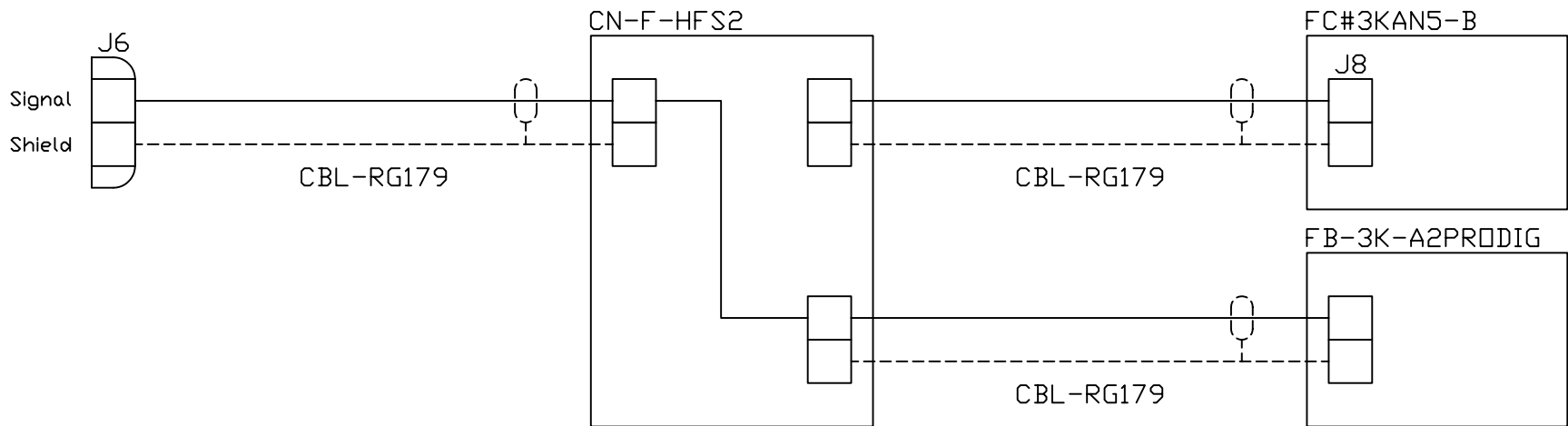
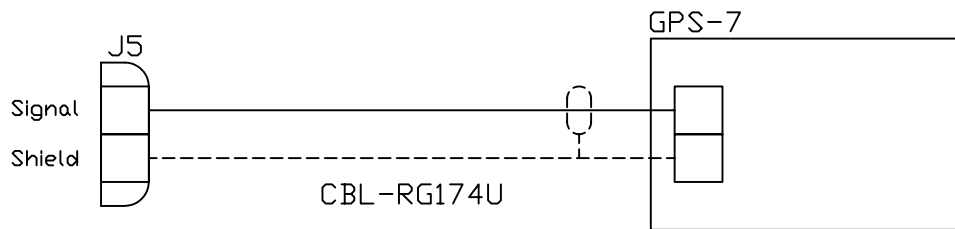

MATERIAL	 Research Concepts, Inc.				
FINISH					
TOLERANCE					
FILENAME					
SHEET 12 OF 13	TITLE 3KAVR Emb Sys Connects	SIZE A	DRAWN BY ECG	DWG NO.	REV A

Red & Green Buttons

REVISIONS			
REV	DATE	DESCRIPTION	APPROVED

JA (RED BTN)

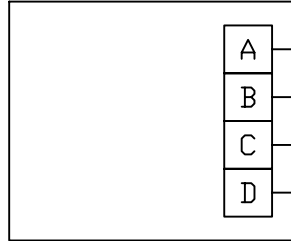

W-22G-RED

W-22G-RED-WHT

W-22G-BLUE

W-22G-BLUE-WHT

FC#3KAN5-B

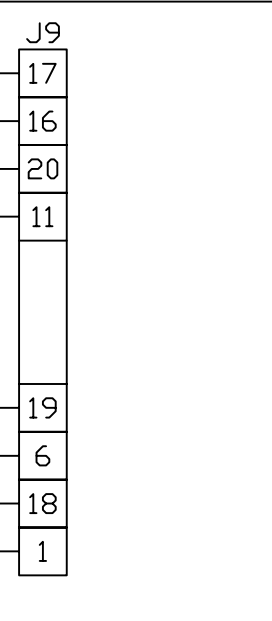

JB (GREEN BTN)

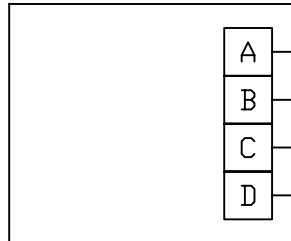

W-22G-GREEN

W-22G-GRN-WHT

W-22G-VIOLET

W-22G-VLT-WHT

MATERIAL	 Research Concepts, Inc.				
FINISH					
TOLERANCE					
FILENAME					
SHEET 13 OF 13	TITLE 3KAVR Emb Sys Connects	SIZE A	DRAWN BY ECG	DWG NO.	REV A