

ENCLOSURE SPECIFIC DATA for AVL Technologies Multiple Mounts

Revision: 19 August 2011

1.0 INTRODUCTION

1.1 Appendix Organization

This appendix is provided as a supplement to the baseline RC4000 User's Manual which describes the PCB board stack that is common to all systems. Section 2 describes the mechanical aspects of the controller, while section 3 describes the electrical connections.

2.0 MECHANICAL

2.1 RC4000 Antenna Controller Chassis and Lid

For the U6 mount, the ACU is mechanized as an embedded controller. The PCB board stack is located inside a weatherproof enclosure. Figure 1 shows the ACU.



Figure 1

The chassis of the RC4000 consists of a frame with a floor, and separate end panels and lid. Figure 2 shows the chassis frame. 10-32 blind PEMs are provided on the bottom and sides of the chassis for mounting the ACU.

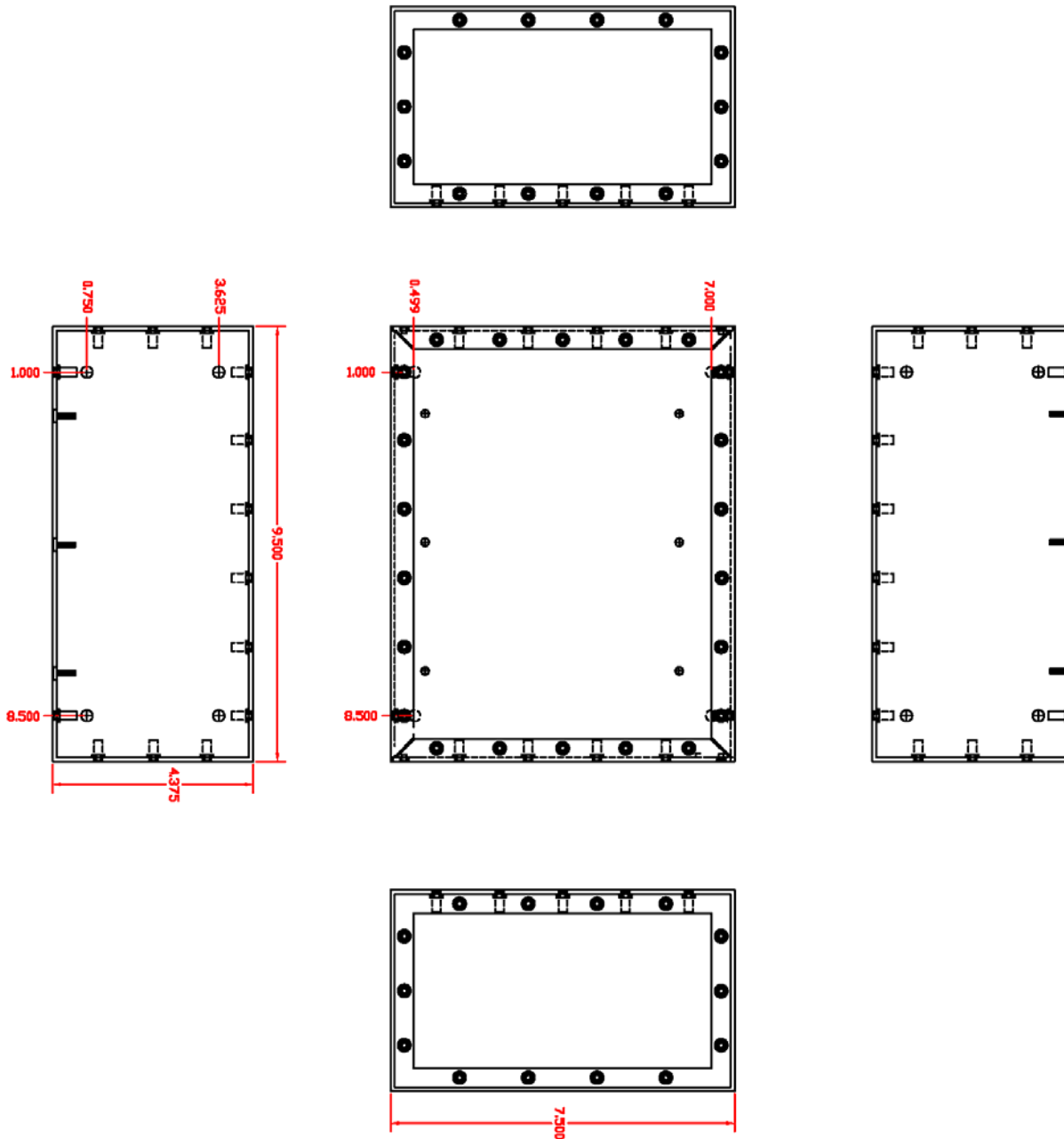

Figure 2

Figure 3 shows the lid of the enclosure.

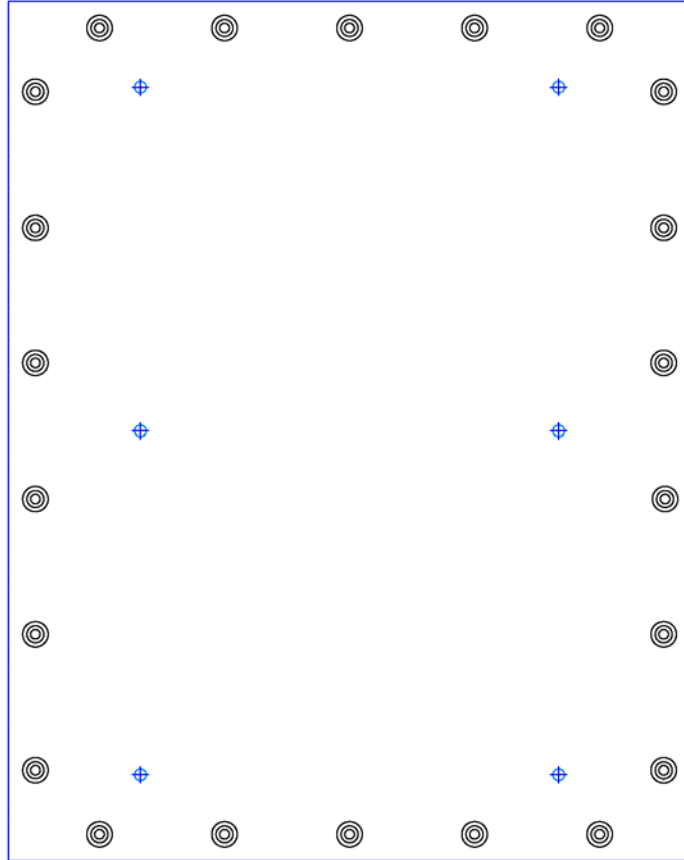

Figure 3

2.2 RC4000 End Panels

The RC4000 end panels are where the connectors are located. The User Interface end panel contains connectors that the user may need to frequently have access to, such as the AC power, Ethernet, and buttons, for example. The other end is the Antenna Interface end panel, which includes connectors that primarily go to the antenna itself, such as the motor and sensors connections. Figure 4 shows both end panels, with the Antenna Interface on top and the User Interface on bottom.

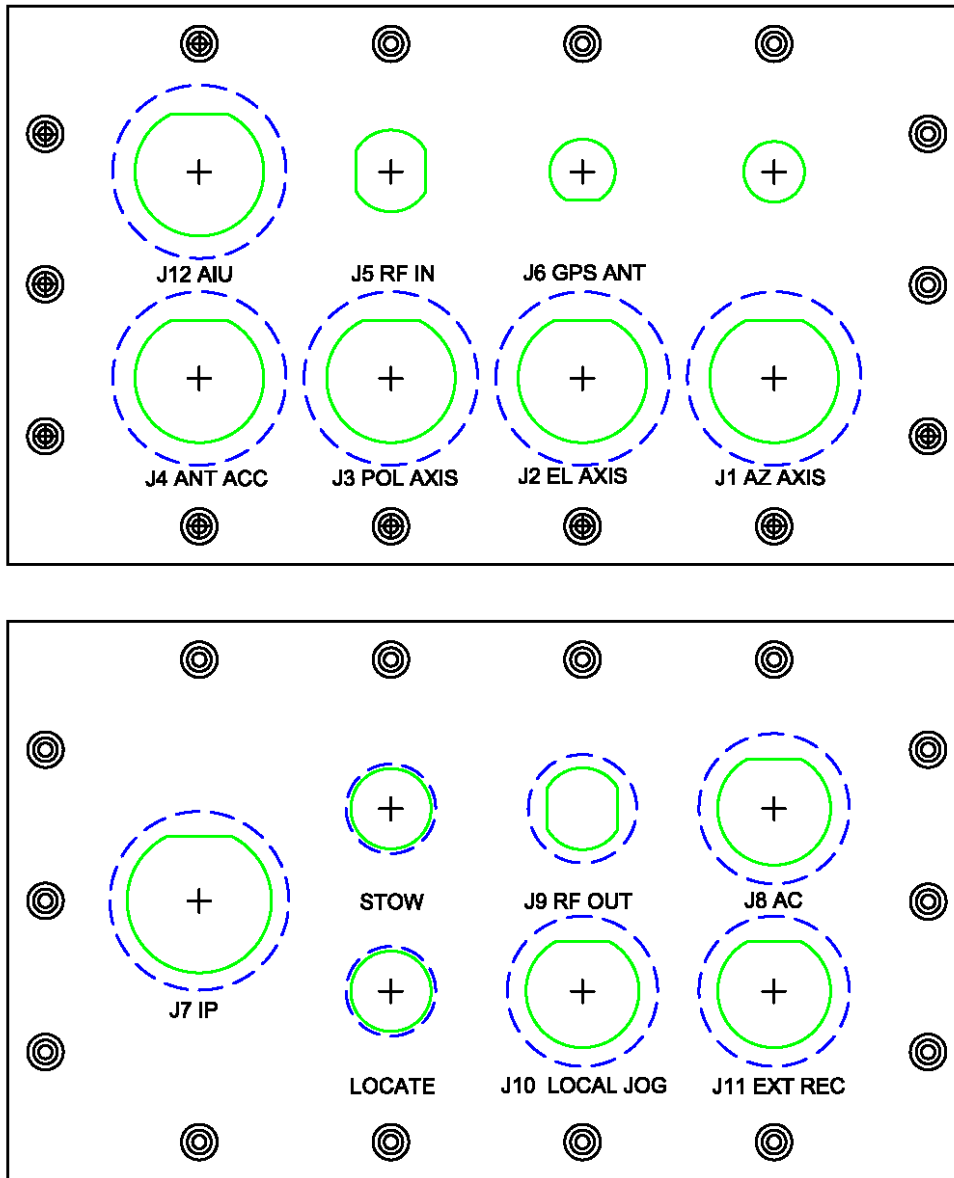

Figure 4

2.3 CONNECTORS

Table 1 provides a list of the external connectors on the enclosure end panels.

Ref Des	Part Number	Description
J1	Amphenol MS3124E14-19S	Azimuth
J2	Amphenol MS3124E14-19S	Elevation
J3	Amphenol MS3124E14-19S	Pol
J4	Amphenol MS3124E14-19P	Acc
J5	Amphenol 172129	RF In
J6	Amphenol 122192	GPS In
J7	Tyco 2008615	IP ** Must use environmentally sealed mating connector **
J8	Amphenol MS3124E12-3P	AC Power In
J9	Amphenol 172129	RF Out
J10	Amphenol MS3124E12-10S	Hand-Held Local Jog Control
J11	Amphenol MS3124E12-10P	External Receiver
J12	Amphenol MS3124E14-18S	AIU

Table 1

3.0 ELECTRICAL

3.1 System Interface

Please refer to the main RC4000 User Manual to become familiar with specific capabilities and functionality of the RC4000 PCB board stack.

Figures 5 and 6 are provided to assist in interfacing to the RC4000. These diagrams list common equipment and how it connects to each connector on the enclosure.

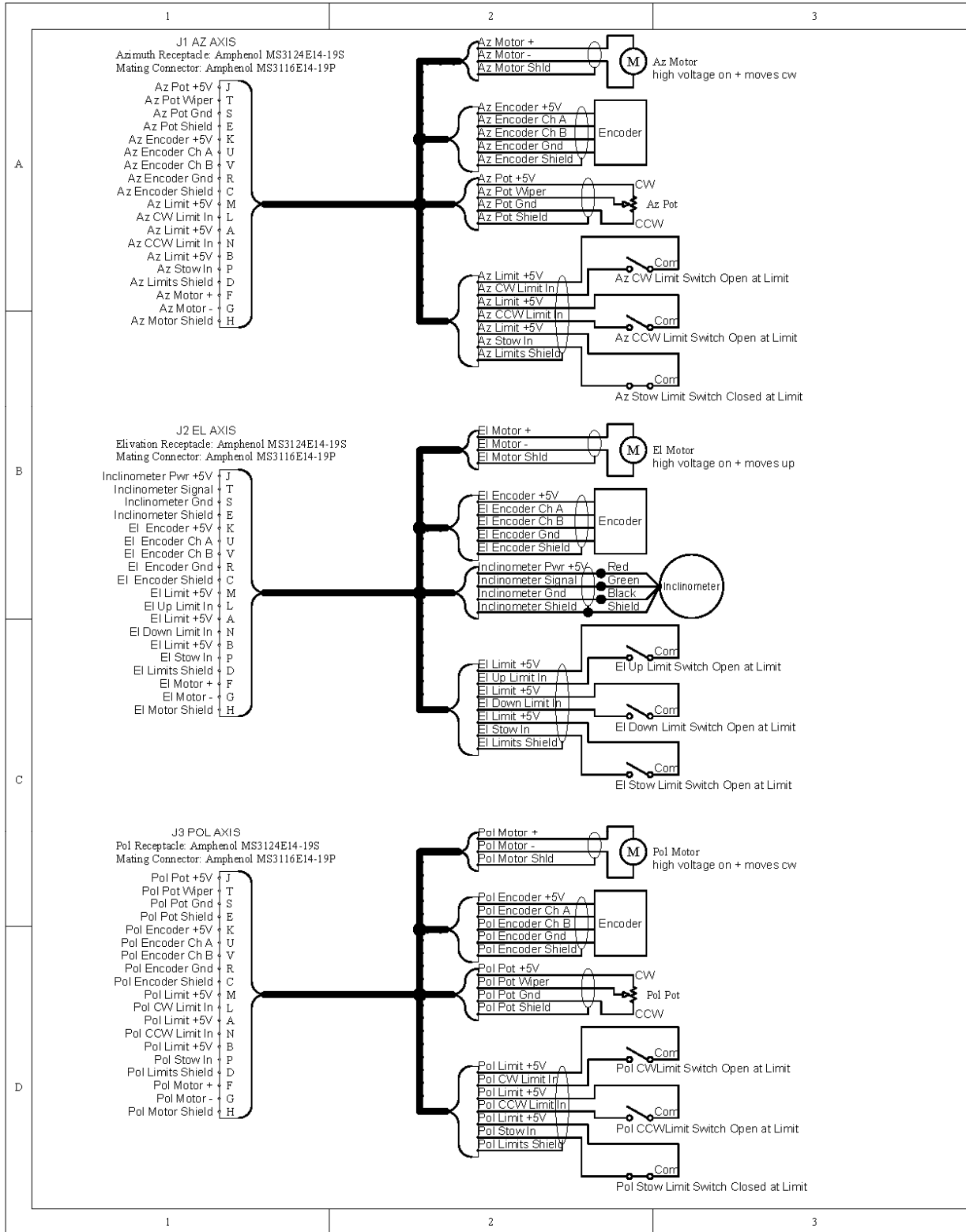

Figure 5

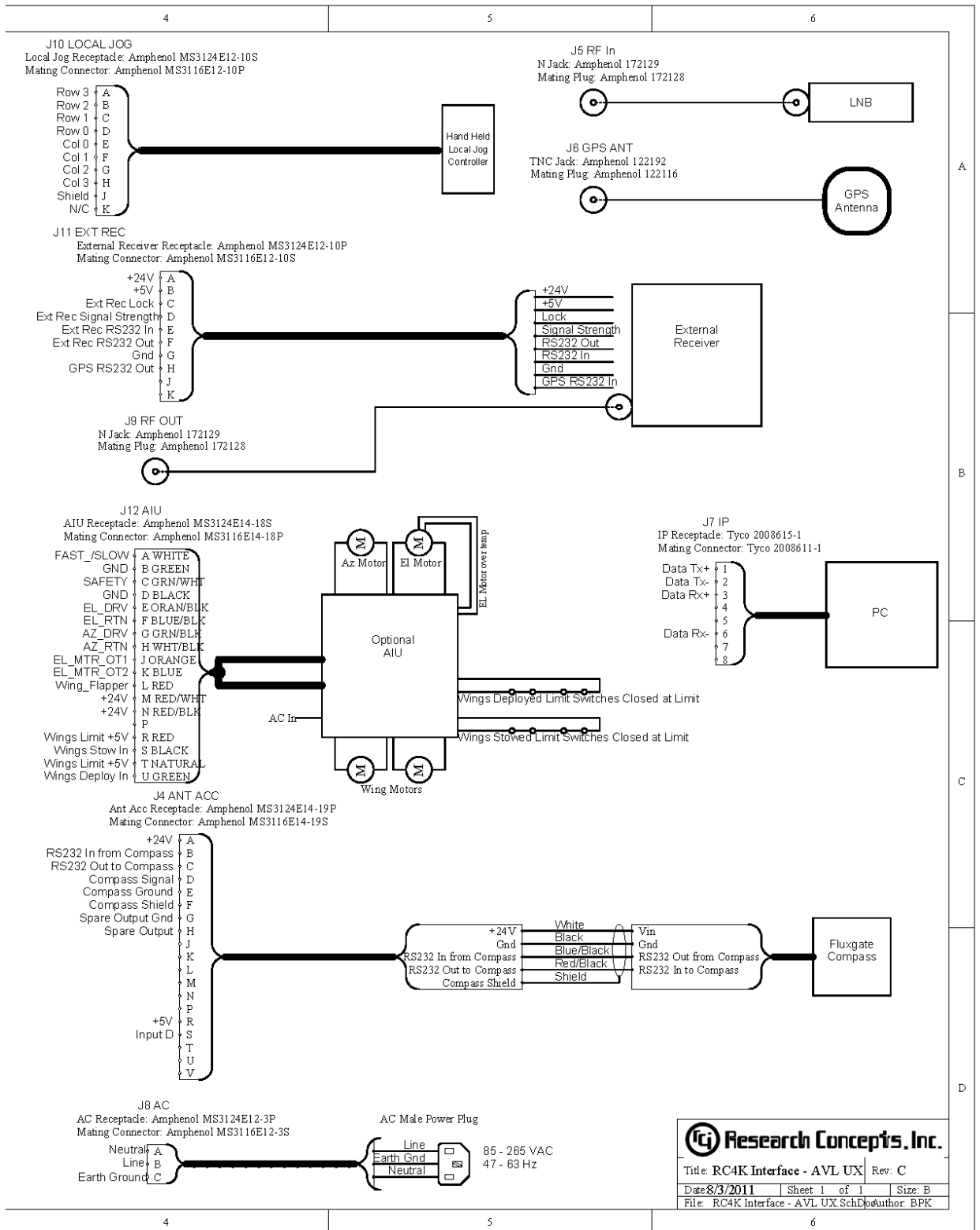

Figure 6

3.2 Internal Wiring

Figures 7 and 8 show the interconnections of the internal wiring to the enclosure. For a more detailed explanation of functions of individual pins, please refer to the main RC4000 User Manual.

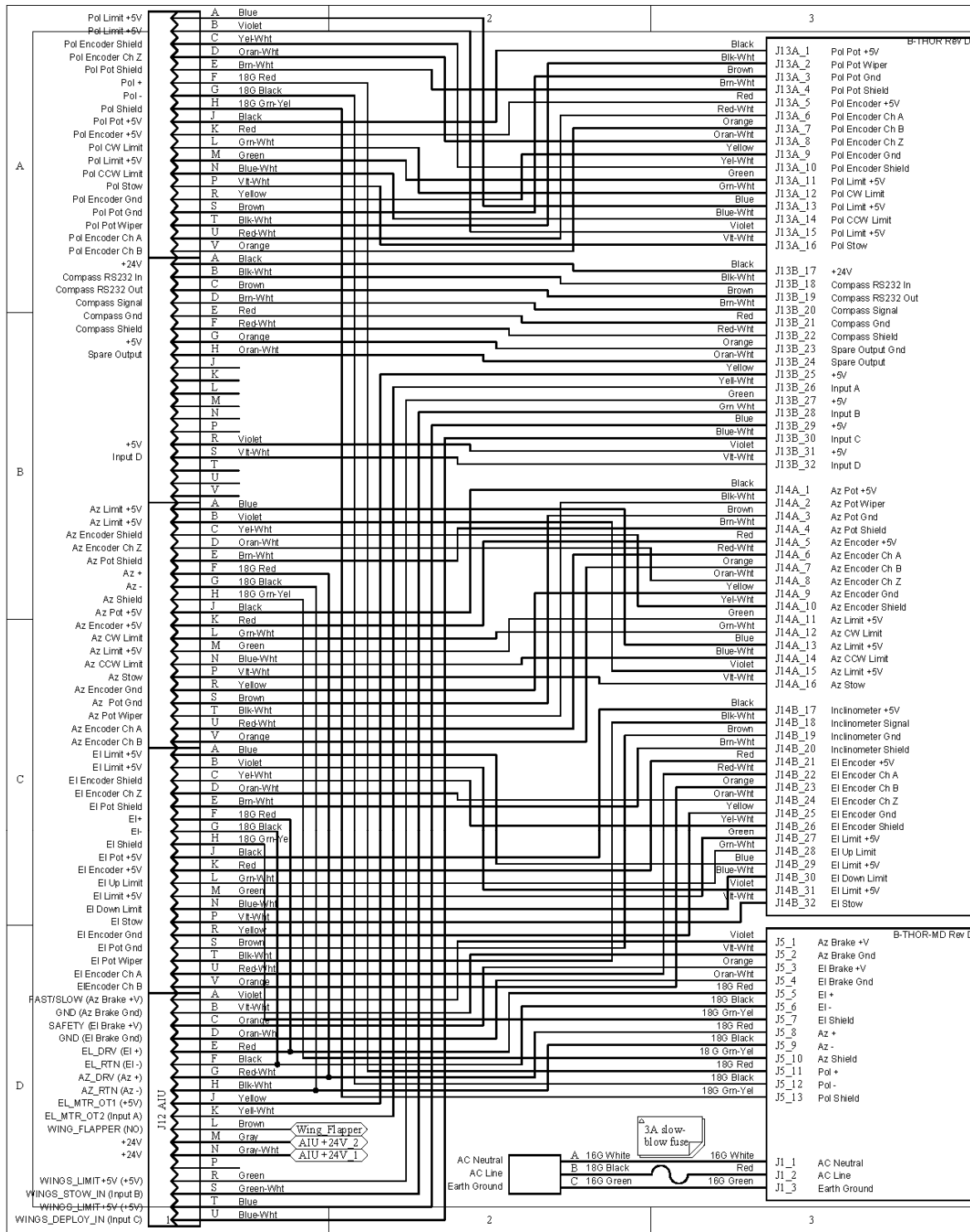
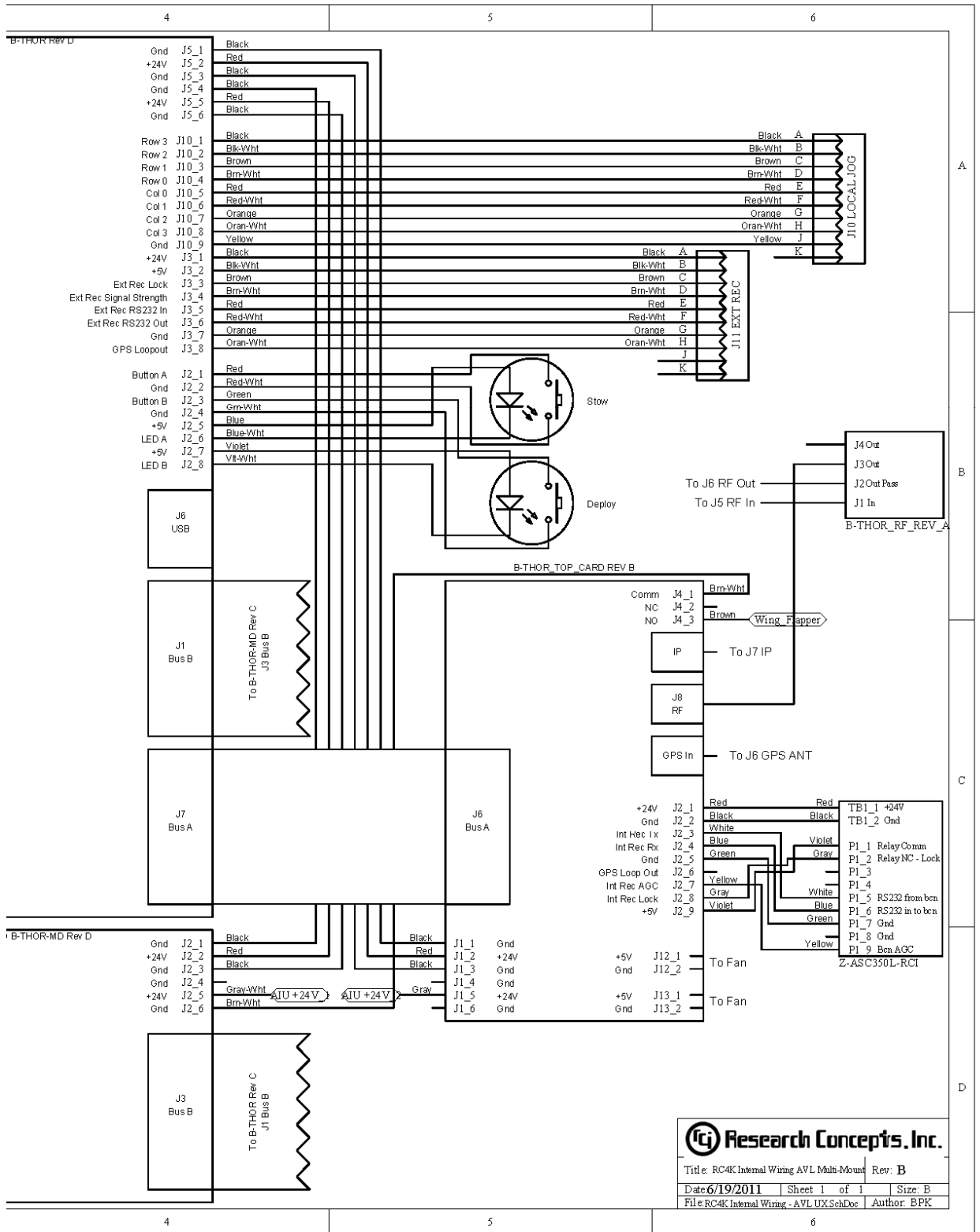

Figure 7



Research Concepts, Inc.
 Title: RC4K Internal Wiring AVL Multi-Mount Rev: B
 Date: 6/19/2011 Sheet 1 of 1 Size: B
 File: RC4K Internal Wiring - AVL UX5chDoc Author: BPK

Figure 8